

VIGIL™ System DVR DRX-50-16 Rear Connector Diagram

Standard PC Connector Legend

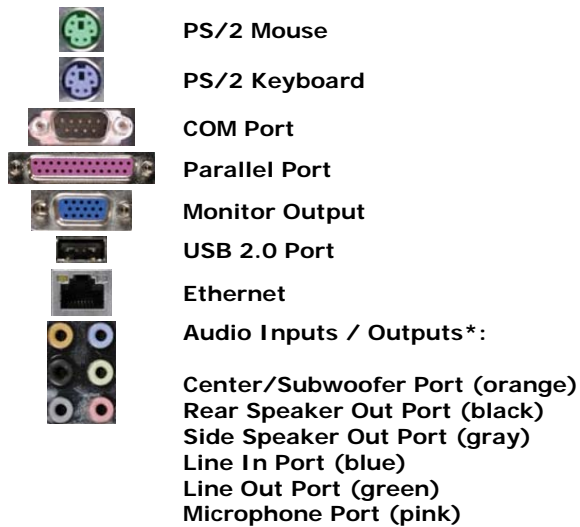

*Port availability may differ between models.

DRX-50-16 DVR Input Connector Diagram

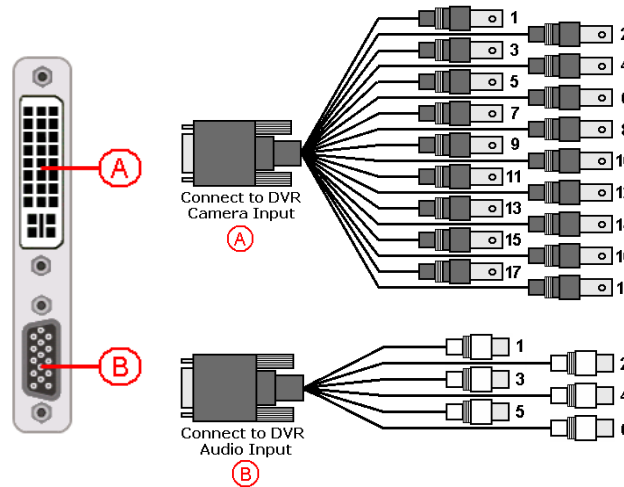

A) 1 – 16: Camera Inputs 1 – 16
 17: Spot Monitor 1 Output
 18: Spot Monitor 2 Output (Multi-screen)

B) 1 – 4: DVR Audio Inputs 1 – 4
 5: Audio Speaker Out
 6: Audio Line Out

Note: Any additional audio inputs are not used for DRX-50 model systems.

Contact Information

If you require more information, or if you have any questions or concerns, please contact 3xLogic Technical Support:
 Toll Free (North America): 1-877-3XLOGIC (1-877-395-6442)
 Email: support@3xlogic.com
 Online: www.3xlogic.com