

VISIX™ 4MP IP Outdoor Dome Camera

This four (4) megapixel IP camera from 3xLOGIC provides high-definition video at a full 2560 x 1440 pixels for outdoor video surveillance applications requiring superior clarity and detail. It is ideal for locations such as schools, government, hotels, banks, museums and supermarkets.

This high-definition camera is packed with all the features you might need for nearly any application including: Motorized lens, intrusion detection; weather and impact protection; motion detection; low-light day/night functionality; and compatibility with a wide variety of standardized network protocols.

The convenient and aesthetically pleasing dome camera format allows unobtrusive and easy installation in a wide variety of areas. In addition, this camera is designed to continue functioning at top performance at temperatures as low as -30°C (-22°F) and as high as 60°C (140°F) allowing a wide range of applications.

It comes standard with a 2.8-12mm vari-focal lens providing support for most applications. Day / Night operation allows use in varying lighting conditions down to 0.009 lux without the need for electronic gain providing better night time video.

Dual streaming permits recording at the highest quality while allowing fast live viewing from anywhere in the world regardless of available bandwidth. In addition, with full support for both variable bit rate and variable frame rate, the quality of each stream can be matched to available bandwidth for the most effective video quality possible.

When coupled with the VIGIL Series of digital video recorders and Video Management System (VMS) software from 3xLOGIC, superior point-to-point hardware compression and decompression allows for maximum performance of streamed live video providing better video quality, more concurrent streams and a lower overall hit to CPU performance.



Key Features and Benefits	
Lens	2.8mm-12mm
Resolution (Megapixels)	4
2560 x 1440 Resolution	✓
Infrared (Low-Light/No-Light)	✓
Dual Streams	✓
H.265/H.265+/H.264/H.264+/ MJPEG	✓
IP67, IK10	✓
Motorized Focus Lens	✓

CAMERA

Image Sensor:	1/1.8" Progressive Scan CMOS
Lens:	2.8-12mm @ F1.2
Angle of view:	Horizontal FOV 102° to 38° Vertical FOV 53.0° to 21.2° Diagonal FOV 122.2° to 45° motorized
Min. Illumination:	Color: 0.002 Lux @ (F1.2, AGC ON) 0 Lux with IR
Day/Night:	IR cut filter with auto switch
IR Range:	Up to 30 meters
Shutter Times:	1 second to 1/100,000 seconds
Angle Adjustment:	Pan: 0° - 355°, Tilt: 0° - 75°, Rotation: 0° - 355

COMPRESSION STANDARD

Video Compression:	H.265/H.265+/H.264/H.264+/MJPEG
Video Bit Rate:	256Kbps to 16Mbps
Audio Compression:	G.711, G.726, MP2L2, PCM
Video Streams:	5 defined streams, 5 custom streams

IMAGE

Max. Image Resolution:	2560(H) x 1440(V)
Frame Rate:	Main: 25 fps@ 50hz, 30 fps@ 60hz Sub: 25 fps@50hz, 30 fps@ 60hz (704 ×576, 640 × 480) Additional Streams: 25 fps@50hz, 30 fps@ 60hz (varying resolutions)

FUNCTIONS

Alarm Triggers:	Intrusion detection, Defocus detection, Motion detection, Face detection, Dynamic analysis, Tampering alarm, Network disconnect, IP address conflict, Storage exception
Local Storage:	Built-in SD, SDHC, SDXC card slot, up to 256GB
Security:	Password protection, HTTPS encryption, IEEE 802.1x port-based network access control, IP address filter, basic and digest authentication for HTTP/HTTPS, WSSE and digest authentication for ONVIF
Protocols:	TCP/IP, ICMP, HTTP, HTTPS, FTP, DHCP, DNS, DDNS, RTP, RTSP, RTPC, PPPoE, NTP, UPnP, SMTP, SNMP, IGMP, 802.1X, QoS, IPv6, UDP, Bonjour
System Compatibility:	ONVIF (PROFILE S, PROFILE G), ISAPI, SDK

PHYSICAL

Working Temperature:	-30°C - 60°C (-22°F - 140°F); Humidity 95% max (non-condensing)
Weather protection:	IP67
Impact Protection:	IEC60068-2-75Eh, 50J, EN50102, up to IK10
Dimensions (inches):	6.4" × 5.5
Dimensions (mm):	162 × 140.3
Weight:	3.20 lbs. / 1450 g

ELECTRICAL

Power Supply:	12 VDC ± 20%, two-core terminal block
Power Consumption:	12 VDC ± 20%: 1.2 A, max. 12 W, PoE (802.3at, class 3): 42.5 V to 57 V, 0.3 A to 0.2 A

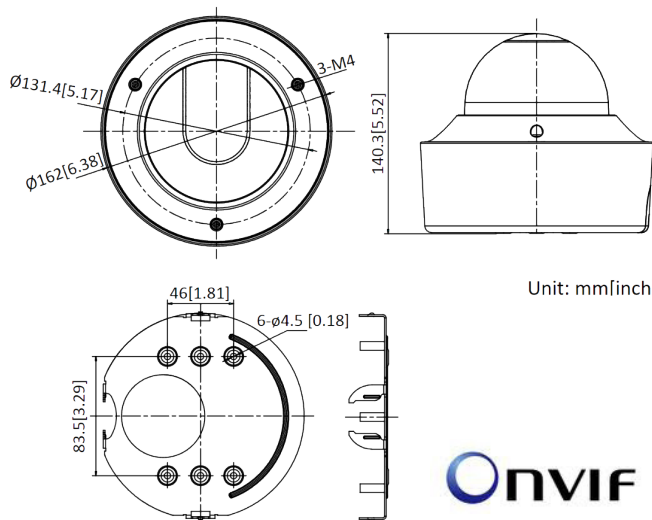

INTERFACE

Communication:	1 RJ45 10M/100M/1000M Ethernet port
Video Output:	1 Vp-p composite output (75 Ω/RCA)
Alarm Input:	1
Alarm Output:	1
Audio Input:	1-ch 3.5 mm audio interface, Mic in/Line in.
Audio Output:	1-ch 3.5 mm audio interface, mono

WARRANTY

Three (3) Year Return to Depot Parts and Labor Warranty

CERTIFICATIONS

FCC, CE, UL

PART NUMBER

VX-4M-OD3-RIAWD:	VISIX 4MP IP Outdoor Dome Camera
-------------------------	----------------------------------

RECOMMENDED MOUNTS

VX-PM-147::	Pendant Mount Adaptor
VX-WM-147:	Wall Mount Adaptor
VX-POLE-147:	Pole Mount Adaptor
VX-CM-147:	Corner Mount Adaptor